

ANCHA 70



Huzurlu ve Sıcak Yuvaların Penceresi

Now Houses are Brighter,
the Windows are More Aesthetic.



$U_f =$
1,3
W/m²K

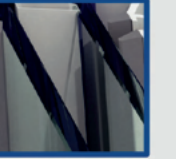
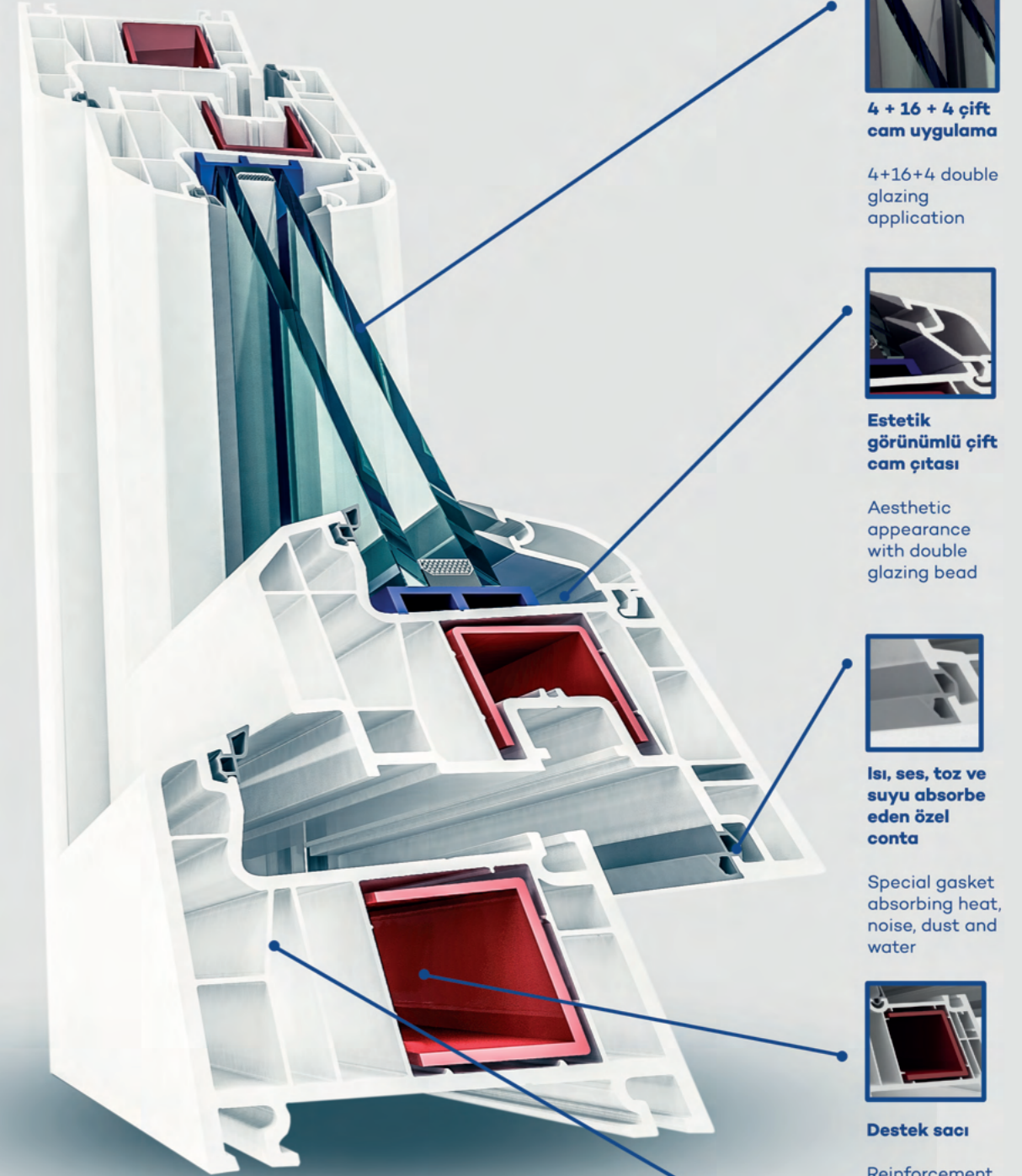

4 + 16 + 4 çift cam uygulama

4+16+4 double glazing application

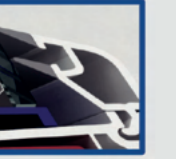

Estetik görümlü çift cam çitası

Aesthetic appearance with double glazing bead



Isı, ses, toz ve suyu absorbe eden özel conta

Special gasket absorbing heat, noise, dust and water



Destek sacı

Reinforcement steel

70MM
5 ODACIK
CHAMBERS

SİSTEM PROFİLLERİ

SYSTEM PROFILES

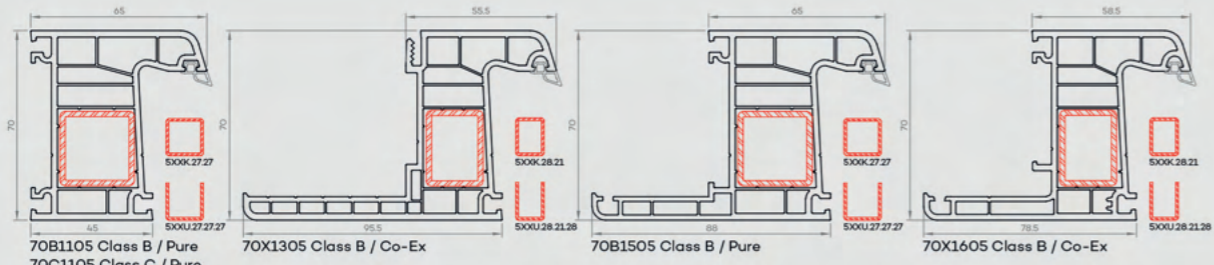

70B1105 Class B / Pure
70C1105 Class C / Pure
70X1105 Class B / Co-Ex
70X1305 Class B / Co-Ex
70B1505 Class B / Pure
70X1605 Class B / Co-Ex

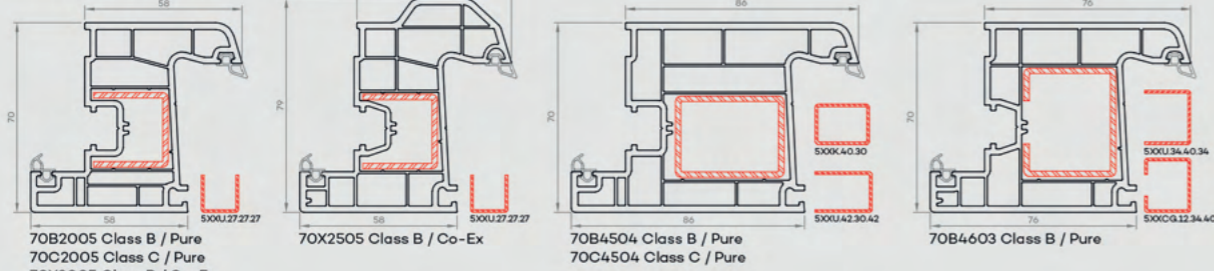

70B2005 Class B / Pure
70C2005 Class C / Pure
70X2005 Class B / Co-Ex
70X2505 Class B / Co-Ex
70B4504 Class B / Pure
70C4504 Class C / Pure
70B4603 Class B / Pure

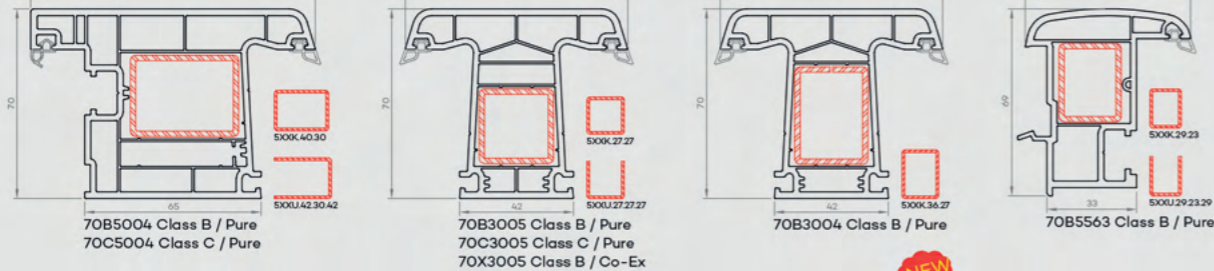

70B5004 Class B / Pure
70C5004 Class C / Pure
70B3005 Class B / Pure
70C3005 Class C / Pure
70X3005 Class B / Co-Ex
70B3004 Class B / Pure
70B5563 Class B / Pure

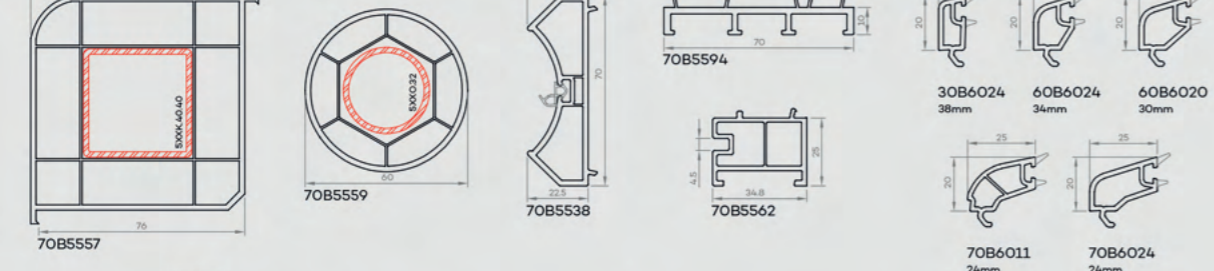

70B5557
70B5559
70B5538
70B5594
30B6024 38mm
60B6024 34mm
60B6020 30mm
70B6011 24mm
70B6024 24mm

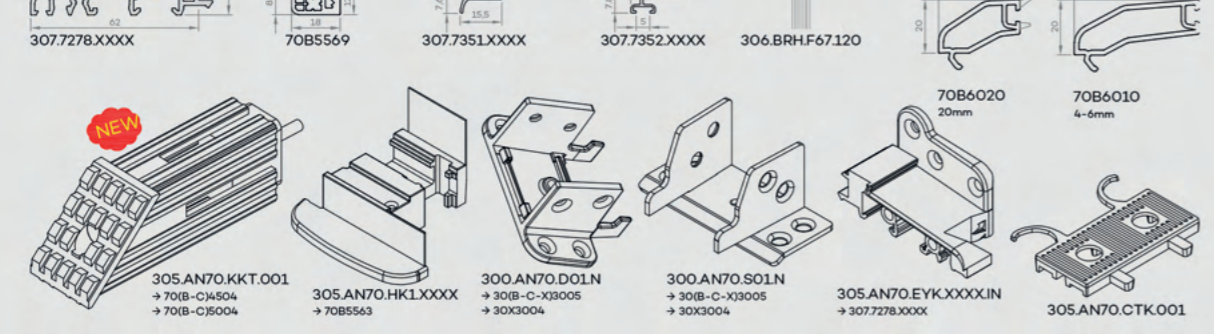

307.7278.XXXX
70B5569
307.7351.XXXX
307.7352.XXXX
306.BRH.F67.120
70B6020 20mm
70B6010 4-6mm
305.AN70.KKT.001
→ 70B-C14504
→ 70B-C15004
305.AN70.HK1.XXXX
→ 70B5563
300.AN70.D01N
→ 30B-C-X13005
→ 30X3004
300.AN70.S01N
→ 30B-C-X13005
→ 30X3004
305.AN70.EYK.XXXX.IN
→ 307.7278.XXXX
305.AN70.CTK.001

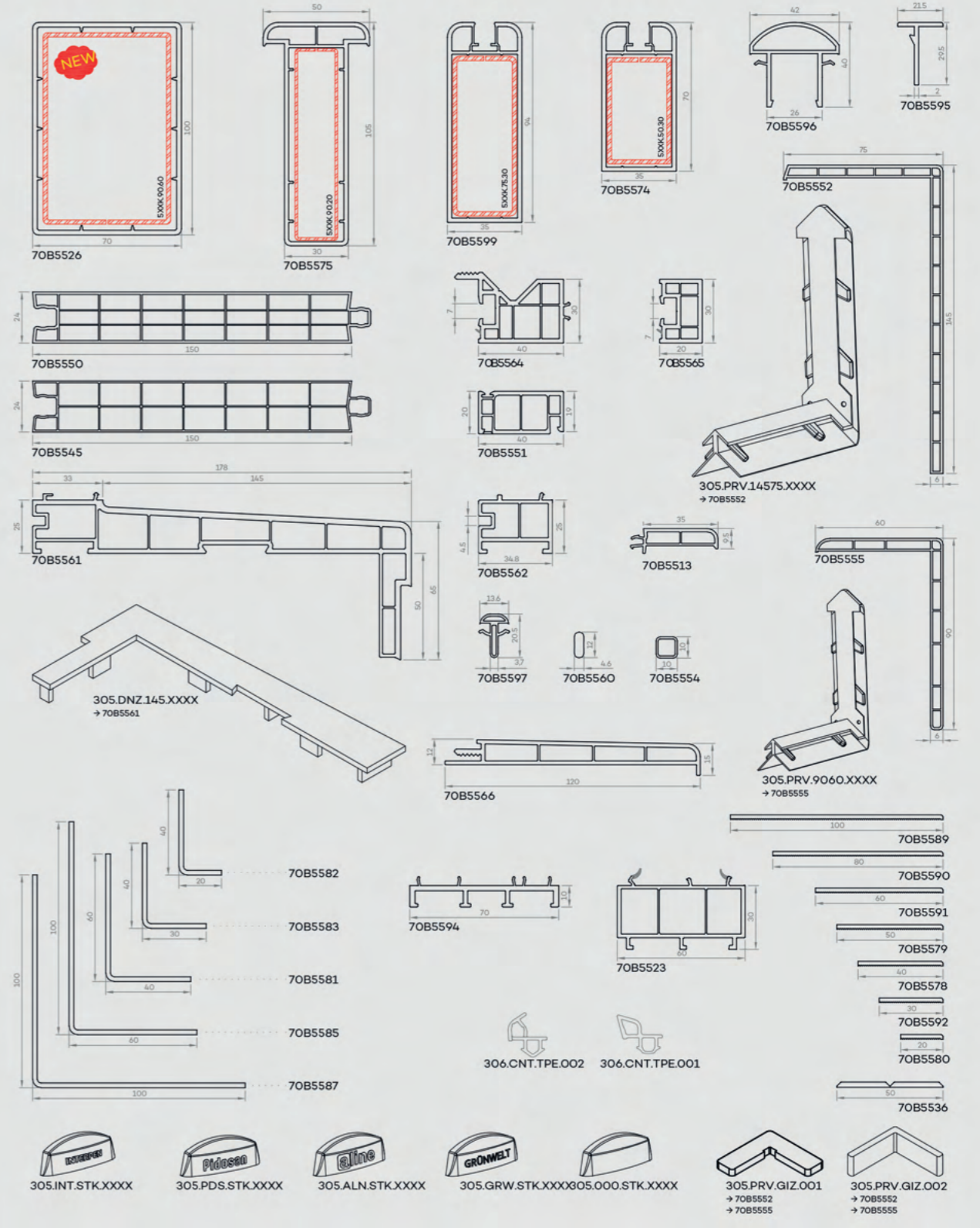

70B5526
70B5575
70B5599
70B5574
70B5552
70B5596
70B5595
70B5550
70B5545
70B5564
70B5565
70B5551
305.PRIV.14575.XXXX
→ 70B5552
70B5561
70B5562
70B5513
70B5555
70B5597
70B5560
70B5554
305.DNZ.145.XXXX
→ 70B5561
70B5566
305.PRIV.9060.XXXX
→ 70B5555
70B5582
70B5583
70B5581
70B5585
70B5587
70B5594
70B5523
70B5589
70B5590
70B5591
70B5579
70B5578
70B5592
70B5580
70B5536
306.CNT.TPE.002
306.CNT.TPE.001
305.INT.STK.XXXX
305.PDS.STK.XXXX
305.ALN.STK.XXXX
305.GRW.STK.XXX805.000.STK.XXXX
305.PRIV.GIZ.001
→ 70B5552
→ 70B5555
305.PRIV.GIZ.002
→ 70B5552
→ 70B5555